

Report

MultiSEPT - Full scale tests of the semicircular spreading gear (SCSG)

Author(s)

Eduardo Grimaldo
Manu Sistiaga
Roger B. Larsen
Ivan Tatone
Fredrik Olsen

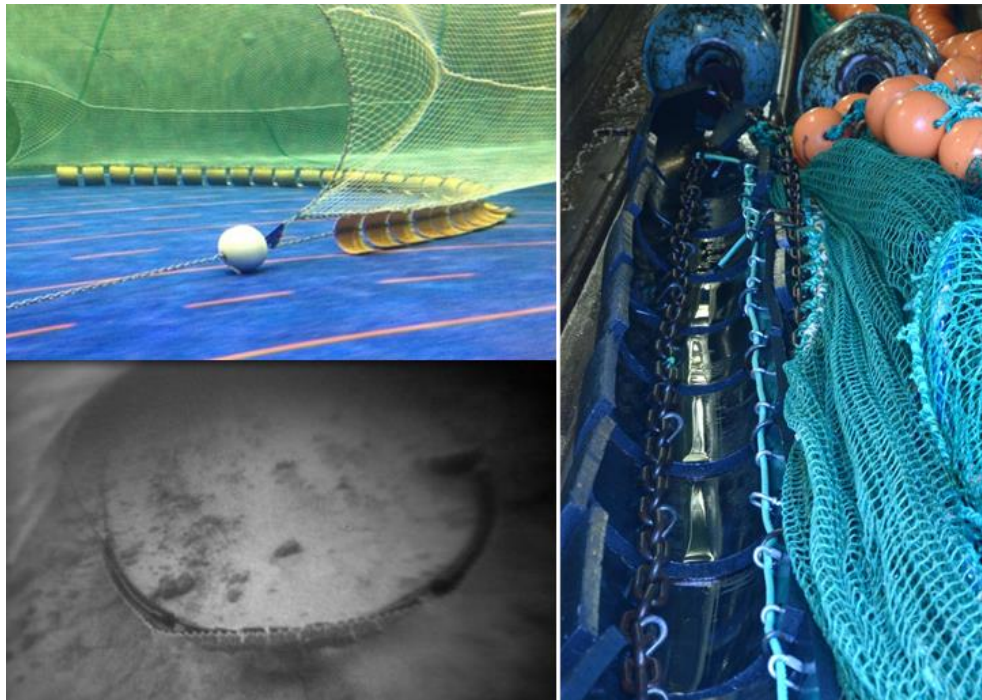

SINTEF Fiskeri og havbruk AS
SINTEF Fisheries and Aquaculture

Address:
Postboks 4762 Sluppen
NO-7465 Trondheim
NORWAY

Telephone:+47 4005350
Telefax:+47 93270701

fish@sintef.no
www.sintef.no/fisk
Enterprise /VAT No:
NO 980 478 270 MVA

Report

MultiSEPT - Full scale tests of the semicircular spreading gear (SCSG)

KEYWORDS:

Fishing technology
Trawl
Bottom trawl gear

VERSION

1.0

DATE

2013-06-24

AUTHOR(S)

Eduardo Grimaldo
Manu Sistiaga
Roger B. Larsen
Ivan Tatone
Fredrik Olsen

CLIENT(S)

The Research Council of Norway
The Norwegian Seafood Research Fund (FHF)
Rolls-Royce Marine AS
Mørenot AS

CLIENT'S REF.

Sigurd Falch/Frøydis Gaarder
Rita Marák
Per Huse
Terje Ringstad/Harald Lausund

PROJECT NO.

830292

NUMBER OF PAGES/APPENDICES:

23

PREPARED BY

Eduardo Grimaldo

SIGNATURE

CHECKED BY

Svein Helge Gjøsund

SIGNATURE

APPROVED BY

Vegar Johansen

SIGNATURE

REPORT NO.

A24271

ISBN

978-82-14-05578-8

CLASSIFICATION

Unrestricted

CLASSIFICATION THIS PAGE

Unrestricted

Table of contents

1	Introduction	4
2	Initial model scale experiments.....	5
2.1	Semi-circular spreading gear (SCSG).....	6
3	Full scale tests	9
3.1	R/V Helmer Hansen.....	9
3.2	Trawls and trawl gears.....	9
3.3	Trawl instrumentation	12
3.4	Data collection and analysis.....	13
4	Results	14
4.1	Trawl geometry and towing tension.....	14
4.2	Gear performance.....	14
4.3	Fishing efficiency – catch comparison	18
5	Discussion	21
6	References	23

Abstract

This report describes full scale tests at sea with the semi-circular spreading gear (SCSG). This activity is part of Work Package 3 (WP3: Development of new ground gear) of the MultiSEPT project.

The spreading of the SCSG and rockhopper gear was measured by use of MARPORT distance sensors. Bottom contact was monitored by use of SCANMAR trawl sensors and by underwater cameras mounted in the headline and belly of the trawl. Fishing efficiency of these two gears was assessed by comparing the size distributions of fish caught by each gear.

The results showed that the spreading (distance between wing-ends) was approximately 7 % higher with the SCSG than with the rockhopper gear for the same door spreading. The SCSG had good bottom contact and passed bottom obstacles (e.g. stones) easily. The size distribution of fish caught with the SCSG was very similar to that caught with the rockhopper, but apparently more cod (over 65 cm) and more haddock (of all sizes) was caught by this gear. However, the number of hauls performed with the SCSP and with the rockhopper was too small to draw a clear conclusion on catch efficiency.

The SCSG is a gear that is easy to rig and handle on deck, it does not require accurate adjustments, it has few control points, it has low weight and the results indicate that its performance at sea is comparable or better than the rockhopper gear for the given bottom conditions.

Further development of the SCSG should emphasise on the choice of material that can reduce wear of the gear and the extent of its life.

1 Introduction

This report is a part of the research project Development of Multirig Semi-pelagic Trawling – MultiSEPT (Research Council of Norway project no. 216423, The Norwegian Seafood Research Fund project no. 216423/O70). The main objective of the project is to reduce NO_x- and other environmental emissions and to increase the energy efficiency of trawling operations for deep-water resources such as Northern shrimp and Northeast Arctic cod, by developing multi-rig semi-pelagic trawling technology.

The present report addresses Work Package 3 (WP3) of this project: Development a new ground gear. Core challenges associated are to lift the trawl doors, central clump(s), sweeps and bridles from the sea bed without losing symmetry, and to avoid the escape of fish under the new ground gear.

In bottom trawling for whitefish (cod - *Gadus morhua*, haddock - *Melanogrammus aeglefinus* and saithe - *Pollachius virens*), the bottom contact of the trawl doors, bridles and sweeps is considered important for herding fish towards the trawl mouth (Main and Sangster, 1983; Korotkov, 1984; Dickson, 1988; Dickson and Engås, 1989; Engås and Godø, 1989a; Wardle, 1983; Winger et al., 2010). Traditional bottom trawls require good contact between the bottom and the ground gear in order to avoid fish escaping under the gear. A lot of fish has been observed to escape under the ground gear, (Main and Sangster, 1981a; Main and Sangster, 1981b; Engås and Godø, 1989b; Godø et al., 1999) and up to 33% of fish have been quantified escaping between the plates of rockhoppers (Ingólfsson and Jørgensen, 2006).

This report describes full scale tests on commercial fishing grounds of a new ground gear SCSG previously tested in model scale in the project (Gjørund et al., 2012). A brief description of the model tests and the SCSG design is given in Chapter 2.

2 Initial model scale experiments

Based on the project proposal and on discussions in a project meeting (cf. minutes dated April 20, 2012) it was decided to carry out model scale tests with ground gear configurations as listed in, in SINTEF Fisheries and Aquacultures [flumetank in Hirtshals](#), Denmark. This flume tank is a large and market leading facility for testing of trawl models. The tank is 21.3 m long, 8 m wide and 2.7 m deep and can generate a water flow of up to 1 m/s.

The goal of the tests was to evaluate the performance of alternative trawl ground gears by measuring the geometry and the forces (tension) in the gear, and by studying bottom contact visually. Bottom topography was included in some of the tests in order to study if (and how) a certain ground gear potentially passes over seabed obstacles, and how the forces in the different parts of the trawl change because of the encounter. A large portion of the loss of catch below the ground gear occurs at the center section of the gear ([Ingolfsson and Jørgensen, 2006](#)), i.e. where the ground gear is close to normal to the towing direction. Therefore, some of the configurations tested are composed by one type of gear at the side (wing) sections and another in the center section. This allows e.g. the use of plate gear at the sides, to provide additional lateral spreading, and a skirt-section in the center to reduce drag, bottom friction and escapement.

The initial test plan included five main types of ground gear:

1) Traditional rockhopper (**RH**).

2) Skirt (**S**)

A ground gear skirt is a net section, normally square meshed, attached to the fishing line of a trawl. Often the length of the skirt is slightly shorter at the bottom than at the fishing line in order to ensure that the bottom line lies ahead of the fishing line. Skirts are used in some types of trawls and (Danish) seines, and function well when bottom conditions are not too rough. For rougher bottoms, a traditional skirt is more likely to tear.

The table also includes a foreseen, but for now unspecified "modified skirt" (**MS**), with the intention that the initial tests provide a basis for developing a skirt that is more resistant to rough bottom conditions.

3) Brush gear (**B**)

The brush gear is basically a rockhopper gear with brushes ("road brooms") between the rockhopper disks; the brushes fill in the openings between the discs and thereby have the potential to reduce escapement.

4) Modified plate gear (**MP**)

The existing plate gear design is sensitive with regard to stability, rigging and operation. Therefore, it requires modifications or a fundamentally new design. The planned test activity includes the development and testing of such a modified (**MP**)

5) Semi-circular spreading gear (**SCSG**)

This is an entirely new design of gear that showed interesting hydrodynamic qualities respect to bottom contact, spreading, and ability to jump over obstacles. This gear was therefore considered as the most promising and chosen for testing in full scale trials.

A more detailed description of the results of these tests is found in [Gjørund et al \(2012\)](#).

The model trawl (scale 1:4) was a Mørenot 440 Redline saithe trawl (Figure 1) with 486 kg of buoyancy (floats) along the headline. The length of the headline was 45.6 m + 8.9 m extension to the tow points (the masts in the upstream end of the flume tank). The length of the fishing line was 25.5 m + 21.2 m extension to the tow points. The fishing line was composed by a 16 mm long-link chain and steel wire, with a total weight of approximately 4 kg/m.

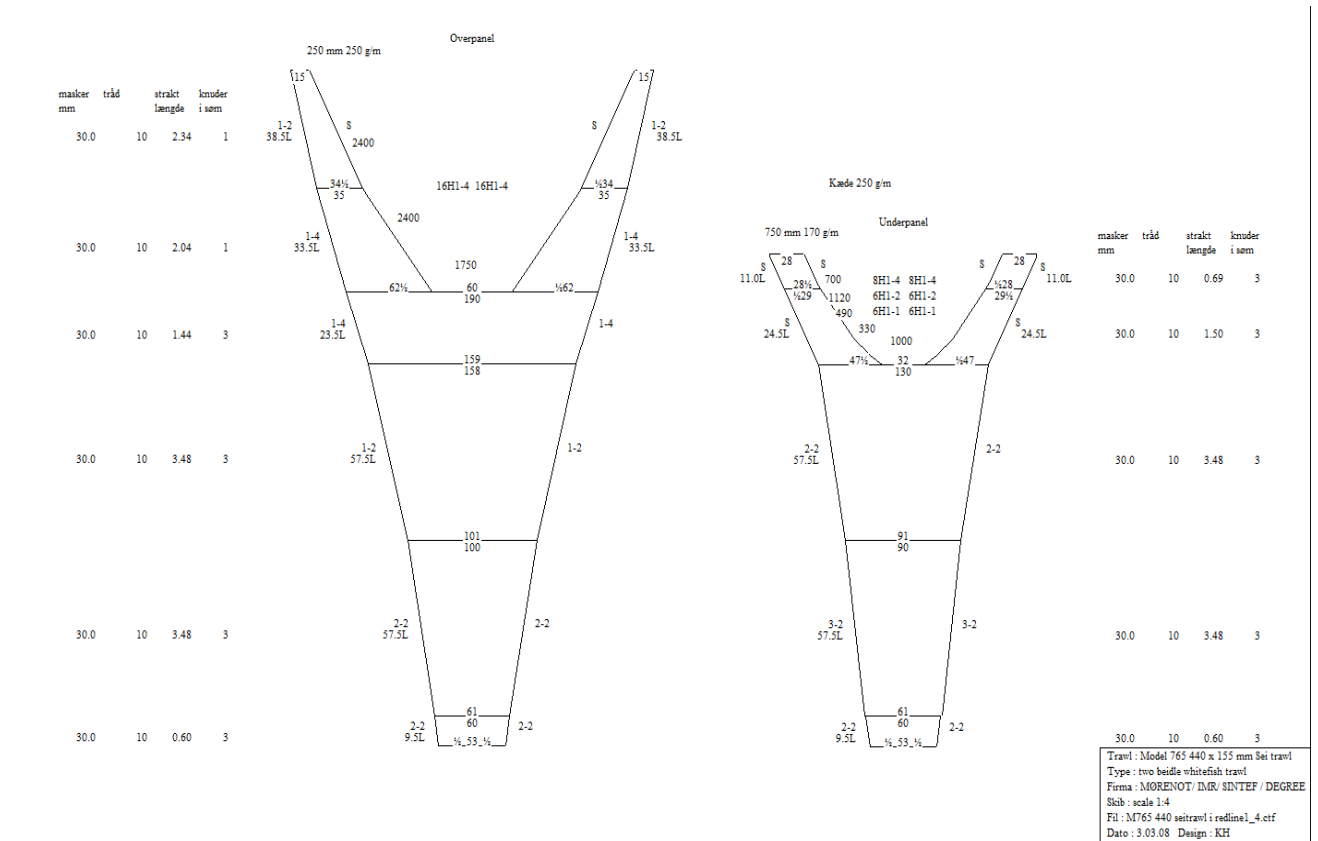
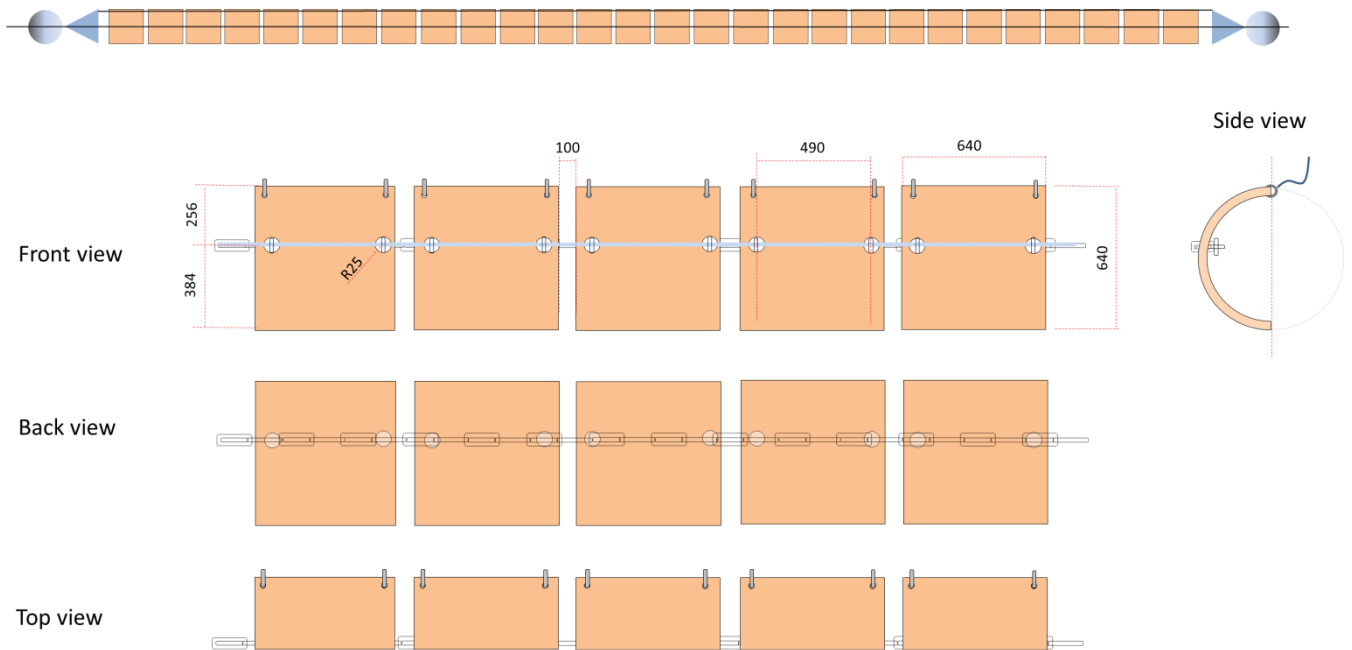

Figure 1. Drawing of the Mørenot 440 saithe trawl.

2.1 Semi-circular spreading gear (SCSG)

This gear consisted of semi-circular profiles made out of a 160 mm (640 mm full scale) diameter PVC pipe. The profiles were 160 mm (640 mm full scale) wide. Two holes were drilled at the two upper corners, and two more at the edge and a small distance above the middle of the profile (the ratio of the semi-circle circumferential sector above and below the middle holes was approximately 40/60) (Figure 2).

The profiles were attached directly to the fishing line using plastic bundle strips through the two holes in the top corners (Figure 3). The gear chain was attached to the profile by plastic bundle strips through the middle holes, with the gear chain behind (i.e. on the rear side of) the profiles. In this way the gear chain is protected from direct contact with bottom obstacles. The spacing between the plates was approximately 25 mm (100 mm full scale).



Chain: LL 19-8
 Wire: \varnothing 16mm
 \varnothing 10mm Quick-link for fastening of wires and center chain

SEMI-CIRCULAR SPREADING GEAR
 Scale 1:1 High 640 mm, length 640 mm, thickness 60 mm
 SINTEF Fisheries and Aquaculture,
 Development of semi-pelagic multi trawling (MultiSEPT)
 NFR project nr.: 216463
 SFH 21.08.12 EGN

Figure 2. The sketch shows the specifications and mounting of SCSG.

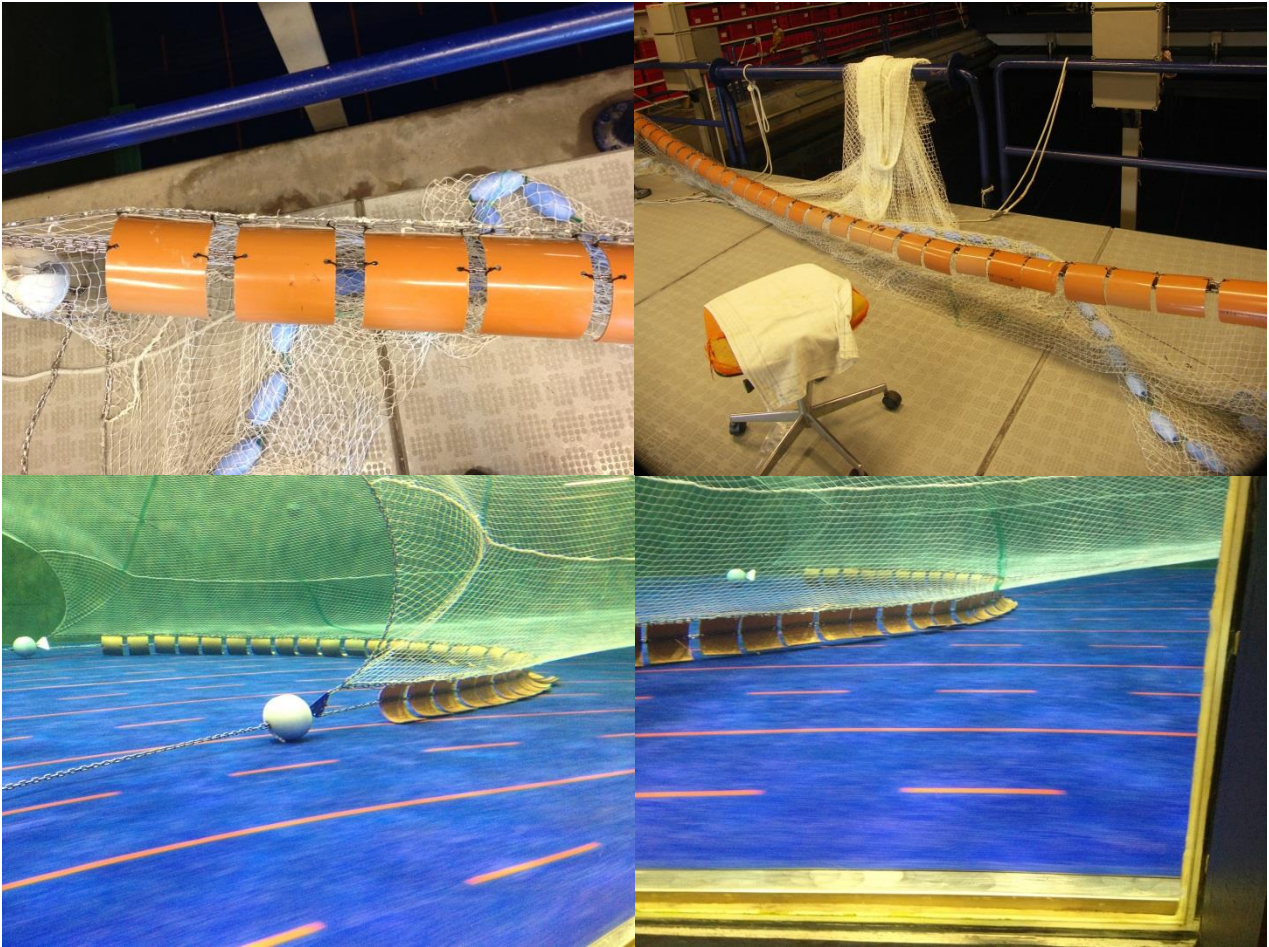

Figure 3. The SCSG with semi-circular profiles and a simple mounting and rigging.

3 Full scale tests

3.1 R/V Helmer Hansen

Full scale tests were performed on board the research vessel R/V "Helmer Hansen" (63.8 m LOA and 4080 HP) in the period 8–10 March, 2013 (Figure 4). "Helmer Hanssen" is a multipurpose vessel, designed for fishery and marine biological, geological and oceanographic surveys in open and ice covered waters (1-2 m drift ice). The trawl deck is provided with double 50 m long trawl ways for bottom trawling and 4 sweep-line winches. The fishing area was off the coast of Troms ($70^{\circ}03'75''\text{N} / 70^{\circ}06'94''\text{N} - 17^{\circ}08'09''\text{Ø} / 17^{\circ}11'66''\text{Ø}$).



Figure 4. The research vessel "Helmer Hanssen" (Source: University of Tromsø)

3.2 Trawls and trawl gears

Two identical ALFREDO 3 trawls entirely built in 80mm PE netting were rigged with two Thyborøn T2 bottom trawldoors (10m² and 3000 kg each), 75 m sweeps (30 m + 45 m), 108 m ground gear and. The trawls had a headline of 36.5 m, a fishing line of 18.9 m and 810 meshes circumference (80 mm nominal mesh size). The foremost sections of the ground gear on both two trawls had five 21" steel bobbins (61 cm in diameter) on each side, and then one trawl was rigged with an 18 m long rockhopper with 21" rubber disks and 8"x 8" spacers (Figure 5), or the other with an 18 m long SCSG built in 50 cm x 50 cm HDPE pipe (Figure 6).

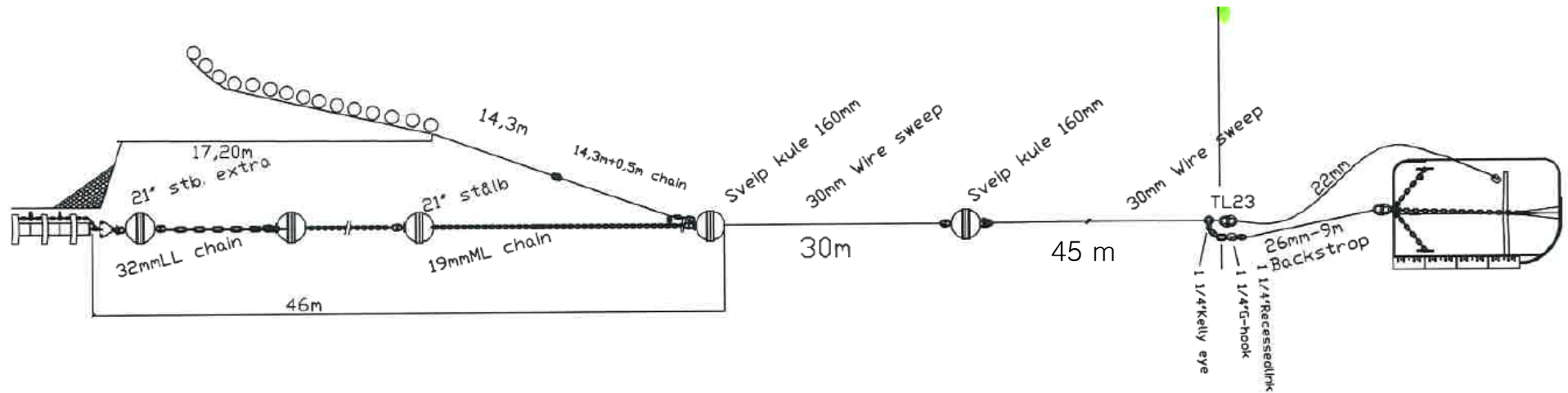

Rockhopper
 21" rubber disks + 8" x 8" spacers

1 x 6.0m side gear (1-2)

1 x 6.0m mid gear (1-1)

1 x 6.0m side gear (1-2)



Figure 5. Rigging of trawl and ground gear

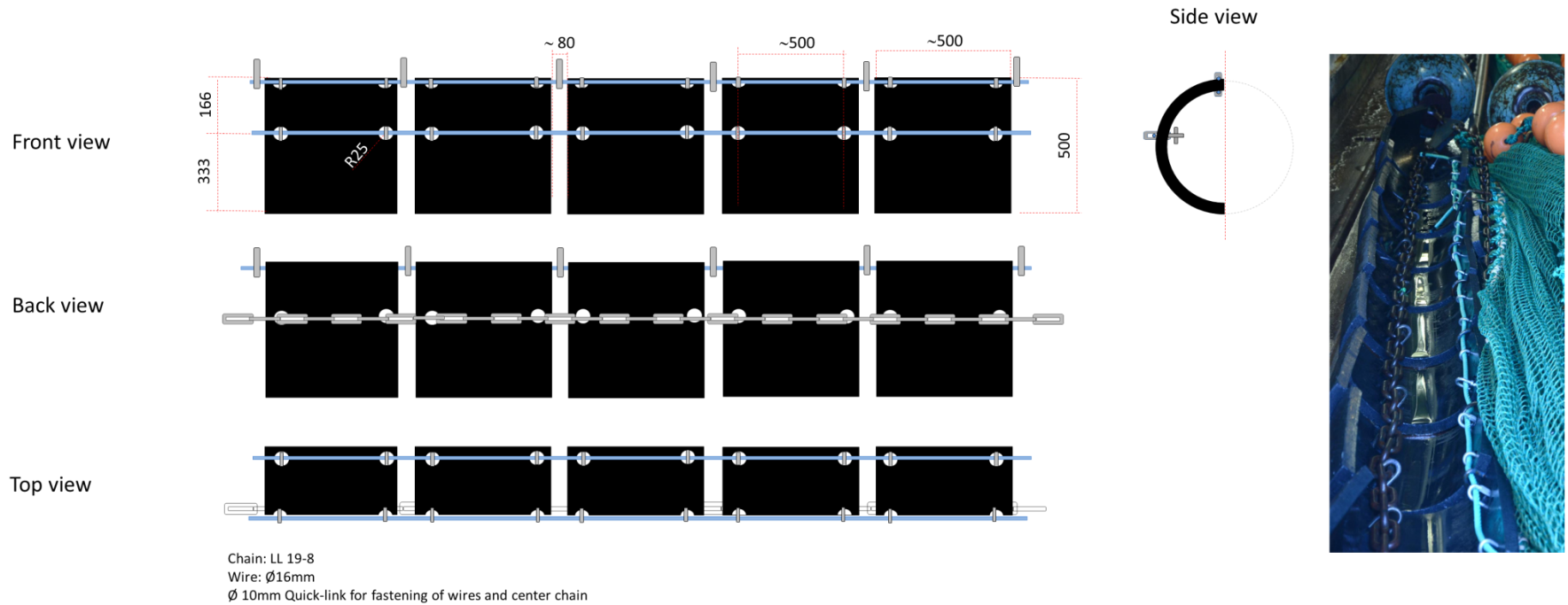

SEMI-CIRCULAR SPREADING GEAR
 Scale 1:1 High 500 mm, length 500 mm, thickness 34 mm
 SINTEF Fisheries and Aquaculture,
 Development of semi-pelagic multi trawling (MultiSEPT)
 NFR project nr.: 216463
 03.10.2012 Eduardo Grimaldo

Figure 6. Semi-circular spreading gear (SCSG)

Both trawls had identical 135 mm codends (nominal mesh size) built in 8mm Ø single twine PE netting (Euronet premium), 70 meshes long and 70 meshes in circumference. Both codends had inner-nets with 60 mm nominal mesh size (2.2 mm Ø single twine PE netting) to retain all fish over 30 cm.

3.3 Trawl instrumentation

SCANMAR and MARPORT trawl sensors were used to measure the trawl- and rigging configuration. An overview of the sensors and their positions in the trawl are shown in Table 1 and Figure 7. In addition, underwater video observations were made in three of the four hauls with the SCSG, using a high definition enhanced low light underwater camera (Model: Konsberg OE14-110) placed over the gear facing backwards in some cases and forwards in others. The winch tension was used to estimate the towing resistance of the trawls.

Table 1:
List of trawl sensors

Sensor	Place	Measurement
SCANMAR distance sensor	Trawl door	Distance between doors
SCANMAR trawl eye	Headline	Trawl height
MARPORT distance sensor	Trawl wing	Spreading of the trawl wings
MARPORT distance sensors	Trawl bossom	Spreading of the rockhopper / semi-circular spreading gear
SCANMAR catch sensor	Codend	Catch size
SCANMAR water speed sensor	Headline, belly, extension piece	Water flow speed

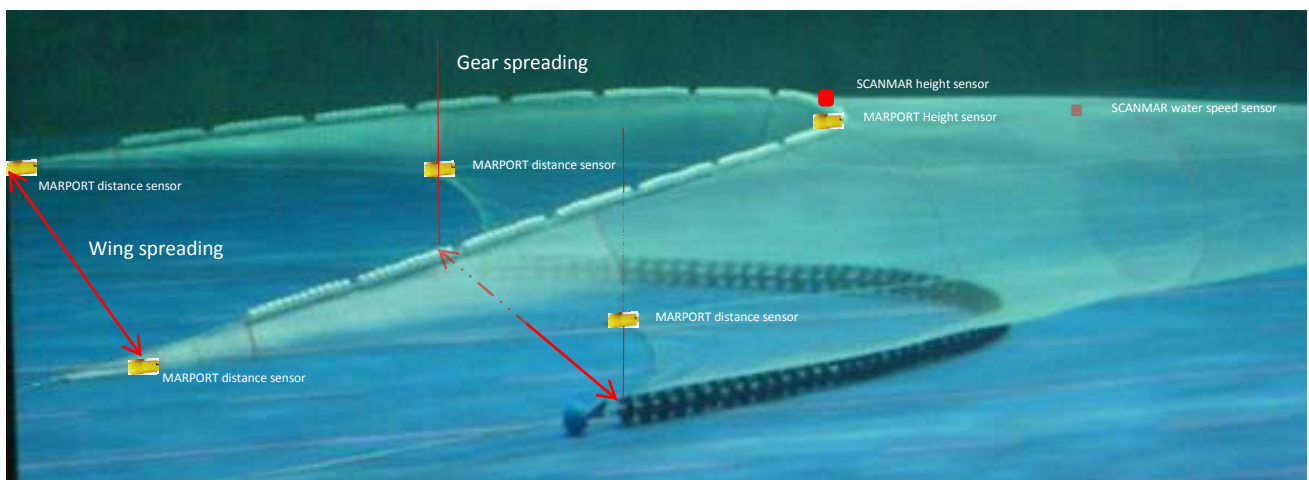

Figure 7. Sketch of the positioning of the trawl sensors.

3.4 Data collection and analysis

The sensor data (cf. Table 1) were logged every 5 minutes, and used to investigate and compare the configurations of the rockhopper- and SCSG trawls.

In order to be able to compare the fishing efficiency (catch) of the two ground gears, all cod and haddock over 30 cm were measured to the nearest centimetre. Subsampling was used only when the catch of each species exceeded 1000 fish. The two trawls, each having a different ground gear, were towed alternately.

We used a catch comparison analysis to study the potential length dependent differences between the cod and haddock captured by the two tested gears. In a catch comparison analysis, the relative length dependent catch rate of two gears tested is calculated in search for a pattern that that would help identifying the potential differences between the gears tested (Holst & Reville 2009). On haul to haul basis the experimental catch comparison rate ($rate_l$) for each of the species separately is given by:

$$rate_l = \frac{n1_l}{n1_l + n2_l} \quad (1)$$

Where $n1_l$ is the number of fish of length l of the given species collected in gear 1 and $n2_l$ is the number of fish of length l of the given species collected in gear 2. The hauls collected with each of the ground gears were standardized by trawling time and subsampling. Further, the number of hauls collected with each of the systems was artificially balanced and then pooled into a single haul in order to make the catch comparison as fair as possible.

In such an analysis, when both gears fish with the same efficiency, $rate_l$ will show a value of 0.5. When gear 1 is more efficient than gear 2, the data point will lay above 0.5. Likewise, when gear 2 is more efficient than gear 1, the data point will lay below 0.5. In order to see the tendencies in the data, a 4th order polynomial model is fit to $rate_l$ through the different length classes.

4 Results

A total of 7 hauls were performed to compare the geometry and fishing efficiency of the rockhopper gear and the SCSG.

4.1 Trawl geometry and towing tension

The SCSG in average had 7 % more spread than the rockhopper gear (16.8 m vs 15.7 m) at similar door spread (~115 m). The averaged measurements are presented in Table 2.

Table 2
Average measurements of door spreading, gear spreading, headline height and tow speed.

Haul no.	Gears	Door spread	Gear spread	Headline height	Towing speed
Haul 28	Semi-circular	111.3 (\pm 4.9)	17.1 (\pm 0.5)	6.2 (\pm 0.3)	3.4 (\pm 0.2)
Haul 29	Semi-circular	117.4 (\pm 1.9)	16.2 (\pm 0.7)	6.1 (\pm 0.8)	3.3 (\pm 0.2)
Haul 30	Rockhopper	114.2 (\pm 3.3)	15.8 (\pm 0.7)	5.9 (\pm 0.4)	3.3 (\pm 0.1)
Haul 31	Rockhopper	115.7 (\pm 1.9)	15.6 (\pm 0.1)	6.0 (\pm 0.4)	3.4 (\pm 0.1)
Haul 32	Semi-circular	95.5 (\pm 0.7)		5.8 (\pm 0)	3.4 (\pm 0.2)
Haul 33	Semi-circular	118.3 (\pm 2.8)	16.9 (\pm 0.5)	5.6 (\pm 0.4)	3.7 (\pm 0.3)
Haul 34	Semi-circular	121.4 (\pm 1.7)	17.0 (\pm 0.4)	5.7 (\pm 0.3)	3.2 (\pm 0.1)
Mean values	Semi-circular	117.1 (\pm 2.8)	16.8 (\pm 0.5)	5.9 (\pm 0.4)	3.4 (\pm 0.2)
	Rockhopper	114.9 (\pm 2.6)	15.7 (\pm 0.4)	6.0 (\pm 0.0)	3.3 (\pm 0.1)

The tension in the winches generally showed large variations (4.3-6.9 tons). For the SCSG the average tension was 5.85 ± 0.64 tons in the port winch 5.80 ± 0.63 tons in the starboard winch. No significant difference in winch tension was found between the rockhopper trawl and the SCSG trawl.

4.2 Gear performance

The video observations showed that the SCSG generally had very good bottom contact throughout the entire tow, and that it easily slid over even large stones. Fish were observed swimming in front of the gear for some minutes before falling back to the trawls (Figures 8, 9 and 10). The observations further revealed two openings approximately 40 cm wide between the mid section and each of the side sections of the SCSG, where fish were observed to escape (Figure 11). These openings were unintentional, and are easily avoided by proper rigging and spacing between the plates.

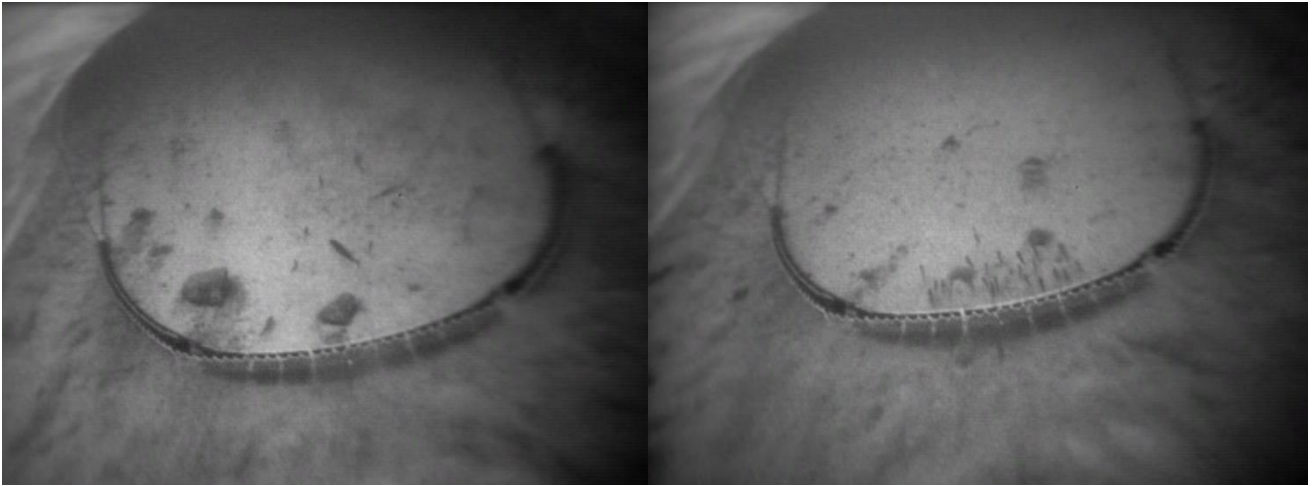

Figure 8 Underwater photographs showing the geometry of the semi-circular ground gear under operation.

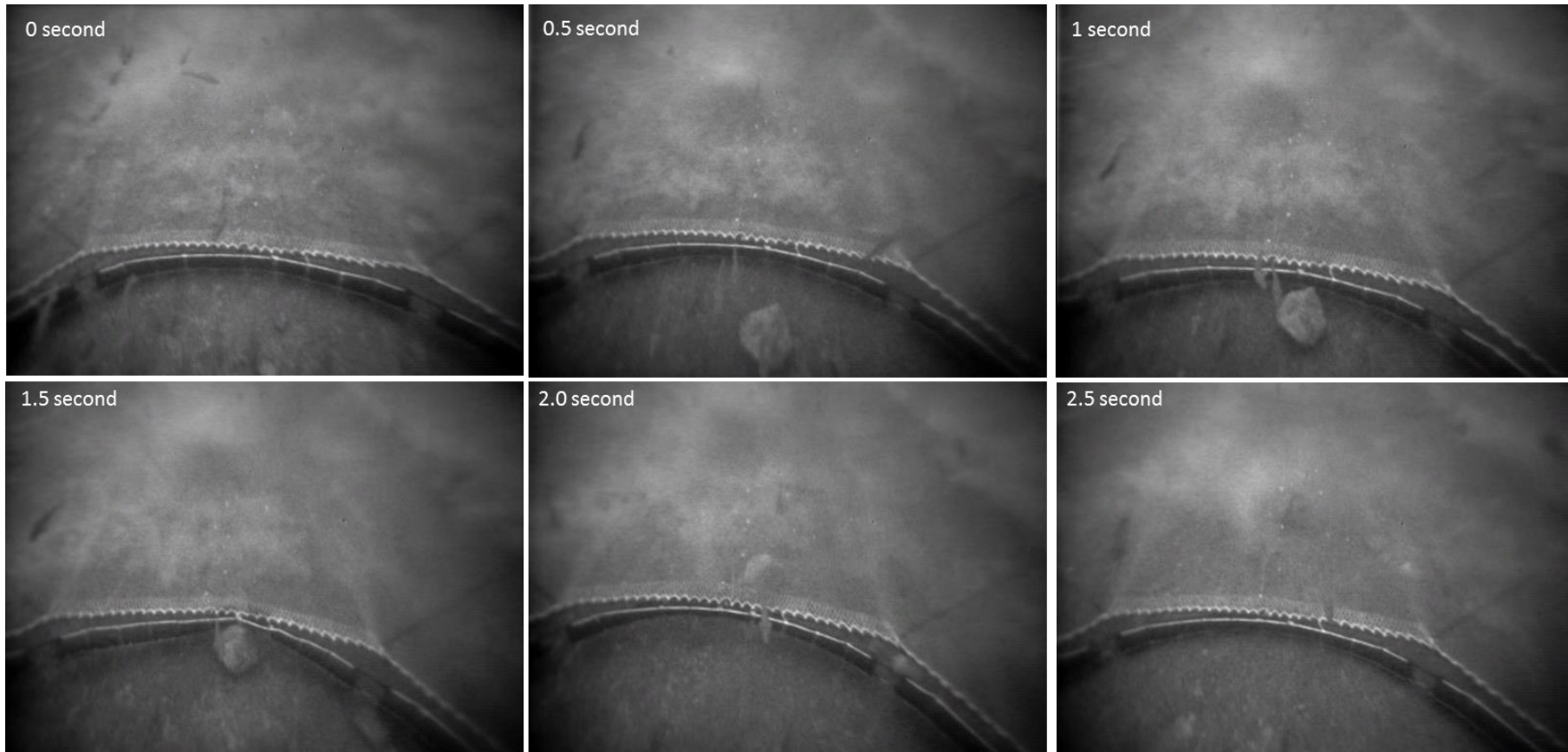

Figure 9 Sequence of underwater photographs showing how easy the semi-circular spreading gear passed over obstacles (stones).

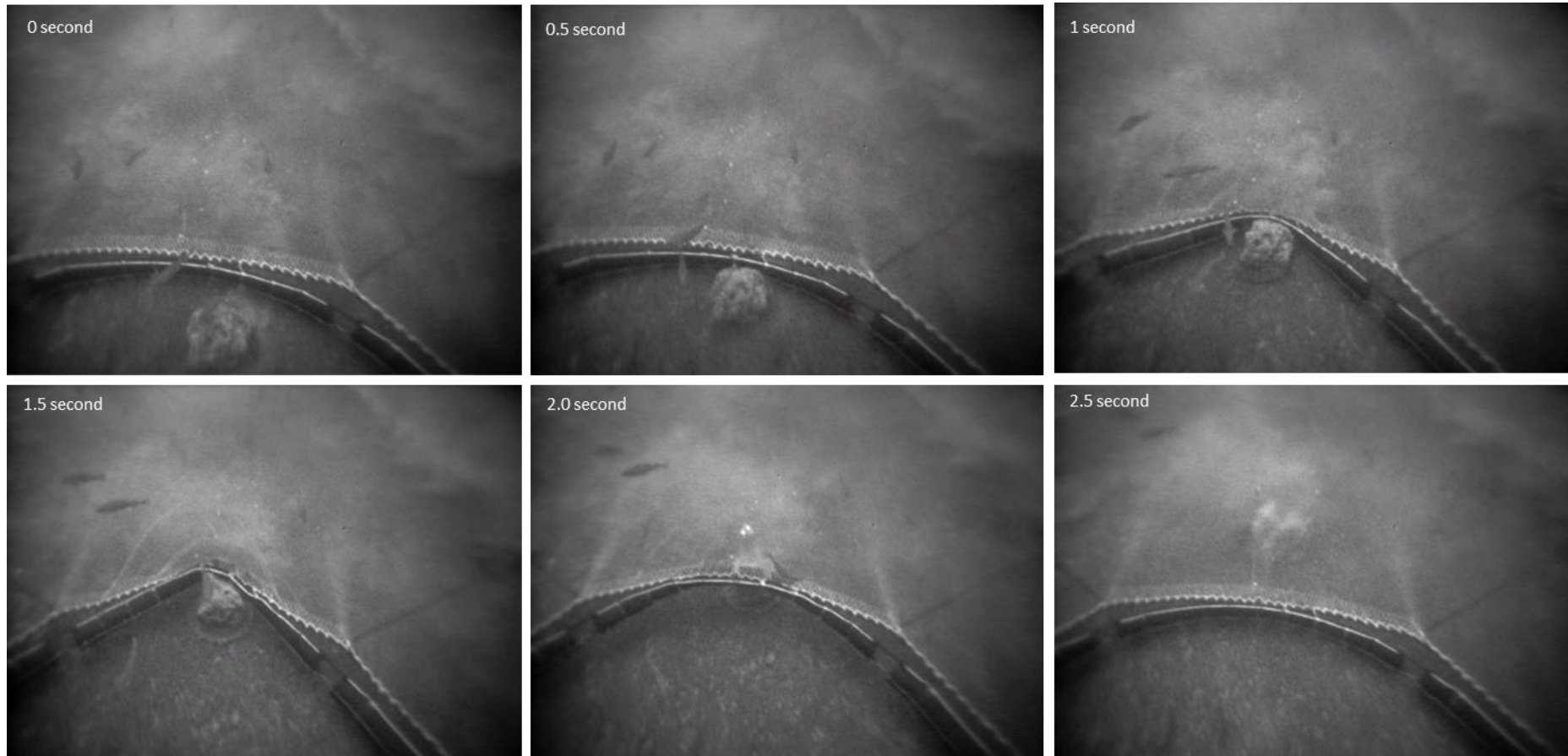

Figure 10 Sequence of underwater photographs showing how easy the semi-circular spreading gear passed over obstacles (stones)



Figure 11. Underwater photograph showing the unintentional open spaces between the mid section and the side sections of the gear.

4.3 Fishing efficiency – catch comparison

The catch data are summarized in Table 3, while the Figure 12 shows the size distribution of total catches in all hauls .

Table 3
Operational information and catches

Haul	28		29		30		31		33		34	
Setup	Semicircle		Semicircle		Rockhopper		Rockhopper		Semicircle		Semicircle	
Position	70°05'13"N		70°06'94"N		70°03'75"N		70°04'13"N		70°04'82"N		70°04'30"N	
	17°10'35"Ø		17°11'66"Ø		17°08'15"Ø		17°08'28"Ø		17°08'36"Ø		17°08'09"Ø	
Trawling time (min)	35		29		10		42		55		28	
Fishing depth (m)	161.5		182.5		161.5		?		?		163.5	
Length (cm)	Cod	Haddock	Cod	Haddock	Cod	Haddock	Cod	Haddock	Cod	Haddock	Cod	Haddock
Number of fish	76	98	448	1 697	396	139	141	60	623	210	441	93
Catch rate (fish/h)	130	168	927	3 511	2 376	834	201	86	680	229	945	199

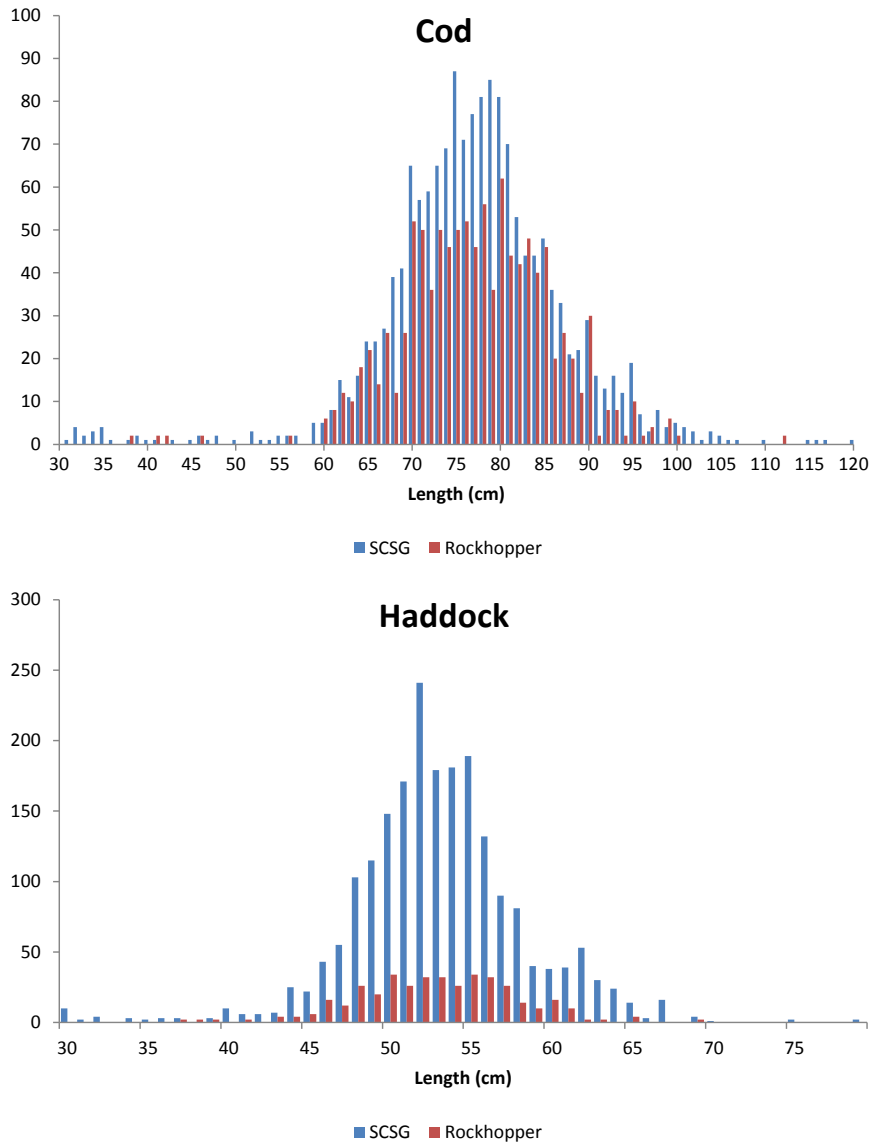

Figure 12: Distribution of cod and haddock captured with the SCSG and rockhopper ground gears during the cruise onboard R/V Helmer Hanssen. Subsampling is considered in the distribution.

The catches of cod and haddock varied considerably from haul to haul, due to varying availability of fish in the area.. For instance, the catch ratio (number of fish caught per hour) of haddock in haul no. 29 was approximately 4.5 times higher than in the following haul. This high variability combined with the low number of hauls means that a standard catch comparison analysis according to Section 3.4 will be statistically weak and unbalanced. We still include such an analysis here, cf. Figure 13, but emphasize that one cannot draw conclusions from it. With reference to Section 3.4, the SCSG is "gear 1" and the rockhopper is "gear 2" in the analysis. Hence in Figure 13, $rate_1 > 0.5$ means that SCSG is more efficient, while $rate_1 < 0.5$ means that the rockhopper gear is more efficient. Figure 13a thus suggests the rockhopper gear catches cod more efficiently than the SCSG for the size range 55-105 cm. For haddock, on the other hand, Figure 13b suggests that the SCSG is more efficient for all fish sizes (lengths). However, as stated above, the statistical basis for these results is insufficient to draw conclusions.

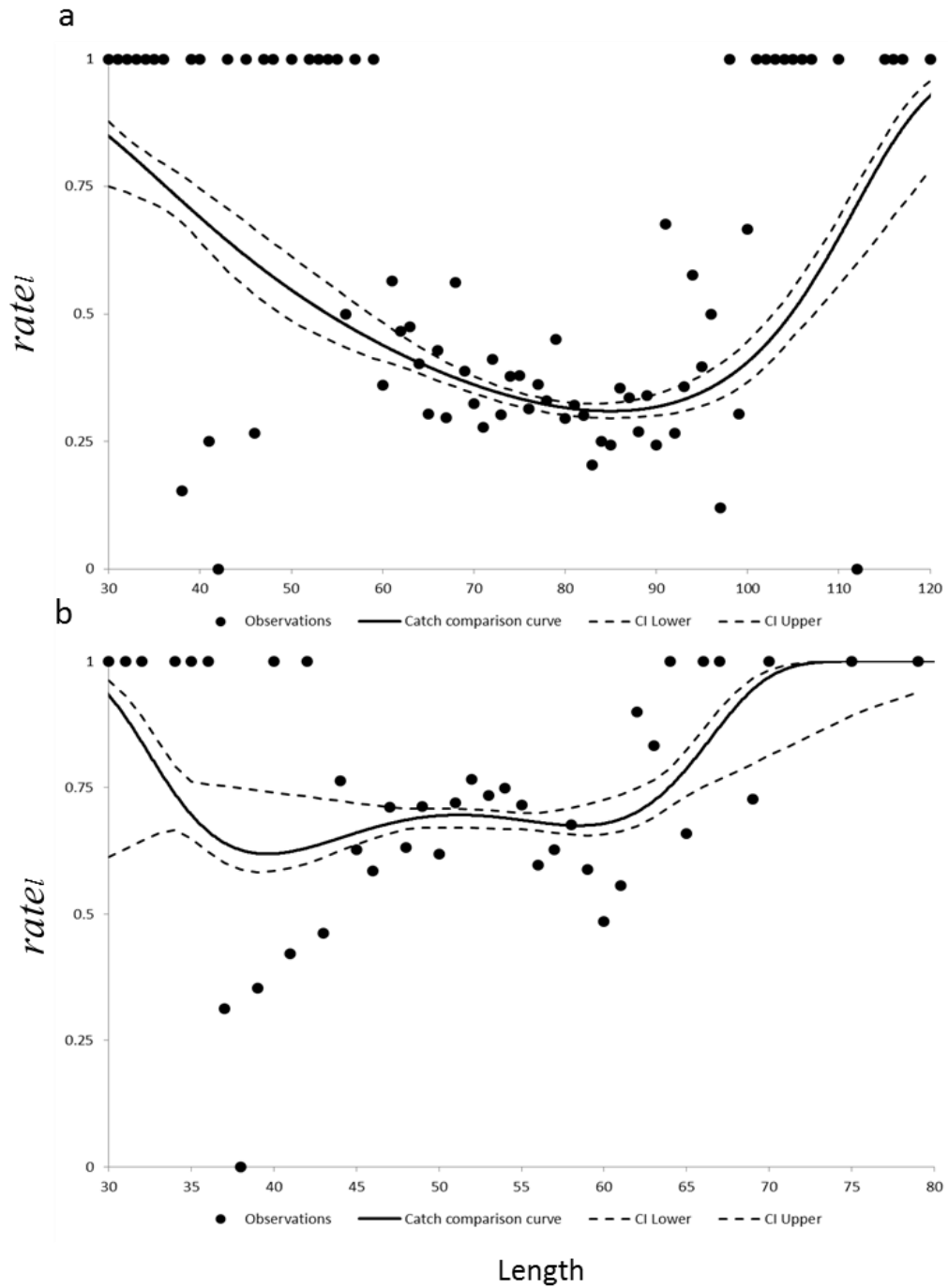

Figure 13: Catch comparison curves and 95% CI-s for cod (panel a) and haddock (panel b). When $rate_l = 0.5$ both gears fish with the same efficiency, when $rate_l > 0.5$ the SCSG is more efficient, and when $rate_l < 0.5$ the rockhopper is more efficient.

5 Discussion

The full scale tests of the SCSG showed that this ground gear was easy to rig and operate, its geometry was stable during towing and it had good bottom contact.

The spreading (distance between wing-ends) was approximately 7 % higher with the SCSG than with the rockhopper gear for the same door spreading. This is mainly due to the hydrodynamic spreading forces acting on the semi-circular plates of the side gear. In this regard the SCSG is similar to the self-spreading ground gear (Valdemarsen and Hansen 2007). However, the self-spreading ground gear is very sensitive to small variations in rigging and geometry, causing the plates to dig or to fly and thus losing bottom contact (Valdemarsen and Hansen 2007) (Fig 13).

These problems are eliminated with the SCSG, which is hydrodynamically and operationally far more stable (Figure 14). In addition, the curved-shaped of the SCSG's sections give the gear a lower angle of attack respect to obstacles (stones), allowing the gear to jump over them very easily.

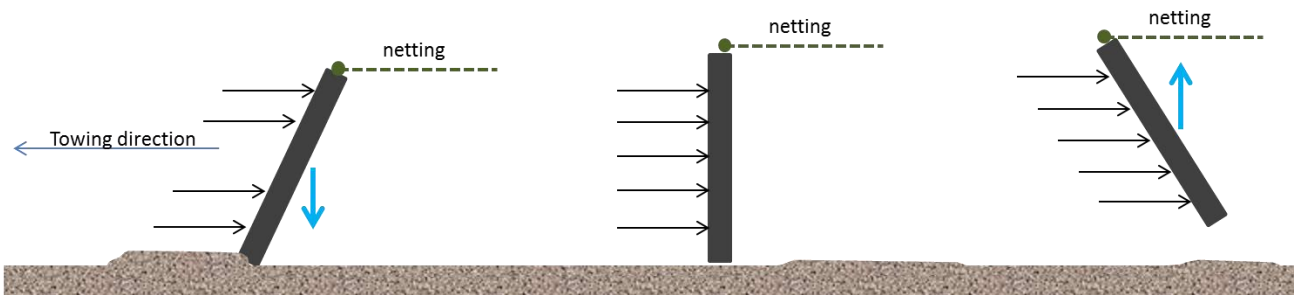

Figure 13 Illustration of the forces acting on the plates of a self-spreading ground gear. A) The plate slopes outwards which gives rise to a downward hydrodynamic force component (blue arrow) which tends to dig the plate into the ground. B) The plate is vertical and subject to pure horizontal hydrodynamic forces (spreading and resistance). C) The plate heels inwards which gives rise to an upward hydrodynamic force component which tends to lift the plate off the ground.

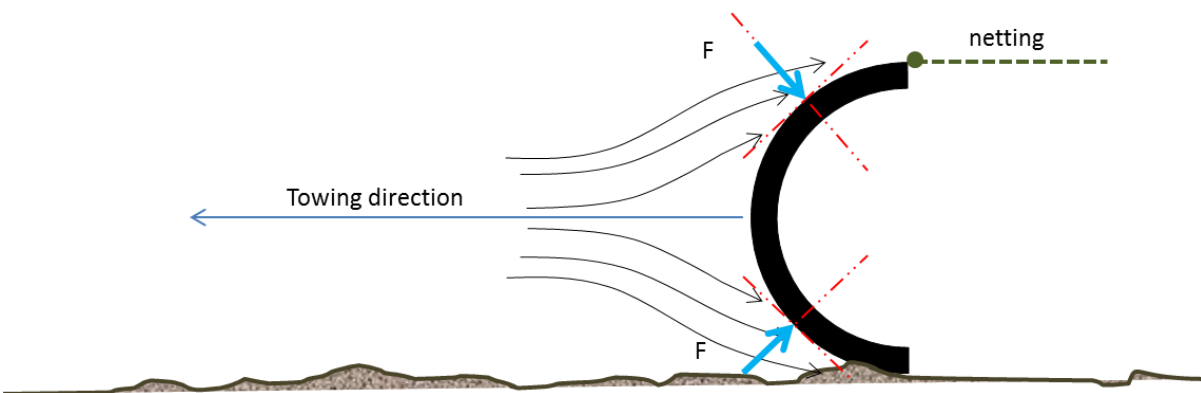

Figure 14 Illustration of the forces acting on the semi-circular plates.

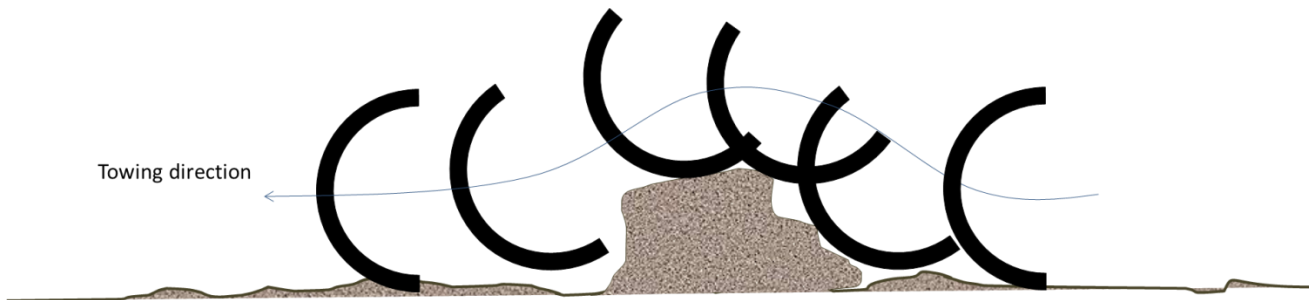

Figure 15 Illustration of a SCSG profile passing over a bottom obstacle (stone).

There was no significant difference in towing tension between the rockhopper and SCSG hauls. However, the contribution from the ground gear is only a minor part of the total towing resistance, hence one cannot expect detailed information about minor differences in drag between the two gear types from recordings of winch tension alone.

The catch comparison analyses summarized in Figure 13 lack robustness due to the low number of hauls and the high variability between the hauls. These analyses are therefore only included to illustrate a method for quantifying the difference in catch efficiency between gears, but the results as such cannot be used to conclude about the efficiency of the two gears.

For such an analysis to be conclusive one would normally require at least 8 hauls with each system when using the alternate-haul method, or use another method such as the pair-gear method (twin-trawling).

Finally, material wear of the SCSG-plates or profiles is one issue to address in the further development of a commercial product based on this first prototype. Very little wear of the semi-circular sections was observed. However, the total towing time with this gear did not exceed 6 hours, and more wear must be expected in a commercial setting.

6 References

- Dickson, W., 1988. Size selectivity of trawl gear in arctic surveys. ICES CM 1988/B:20.
- Dickson, W., and Engås, A., 1989. Change in length composition of different species with the doors and sweeps on and off bottom. ICES FTFB Working Group meeting, Dublin, April 24-26 1989.
- Engås, A. and O.R. Godø. 1989a. The effect of different sweep lengths on the length composition of bottom-sampling trawl catches. *J. Cons. Int. Explor. Mer* 45:263-268.
- Engås, A. and O.R. Godø. 1989b. Escape of fish under the fishing line of a Norwegian sampling trawl and its influence on survey results. *J. Cons. Int. Explor. Mer* 45:269-276.
- Gjøsund, S.H., Hansen, K., Sistiaga, M., Grimaldo, E., 2012. MultiSEPT – Initial model scale tests of traditional and alternative trawl ground gears. SINTEF Report A23318, 34 pp.
- Godø, O.R., Walsh, S.J., and Engås, A., 1999. Investigating density-dependent catchability in bottom-trawl surveys. *ICES J. Mar. Sci.*, 56, 292-298.
- Holst, R. and Revill, A., 2009. A simple statistical method for catch comparison studies. *Fisheries Research*, 95: 254–259.
- Ingólfsson, Ó. A., and Jørgensen, T., 2006. Escapement of gadoid fish beneath a commercial bottom trawl: relevance to the overall selectivity. *Fisheries Research*, 79(3), 303-312.
- Korotkov, V.K., 1984. Fish behavior in a catching zone and influence of bottom trawl rig elements on selectivity. ICES CM 1984/B:15.
- Main, J. Sangster, G.I. 1981a. A study of the fish capture process in a bottom trawl by direct observations from a towed underwater vehicle. *Scott. Fish. Rep.* 23:1–23.
- Main, J., Sangster, G.I., 1981b. A study of the sand clouds produced by trawl boards and their possible effect on fish capture. *Scott. Fish. Res. Rep.* 20:1-20.
- Main, J., and Sangster, G.I., 1983. Fish reaction to trawl – a study comparing light and heavy ground gear. *Scott. Fish. Res. Rep.* 27.
- Valdemarsen, J.W., Hansen, K., 2007. Kommersialisering av komponenter for ny type torskestrål. Rapport fra Havforskningen, Nr. 11, 2007, 40 s.
- Wardle C.S., 1983. Fish reaction to towed fishing gears. In MacDonald A.G. and Priede I.G. (Eds.). *Experimental Biology at Sea*
- Winger, P.D., Eayrs, S., and Glass, C.W. 2010. Fish behaviour near bottom trawls. In: *Behavior of Marine Fishes: Capture Processes and Conservation Challenges*. Edited by P. He. Blackwell Publishing. pp. 67-103.



Technology for a better society

www.sintef.no