

Verktøy igjen som virker?

Kenneth Brandal



tegnere.no / arkitektstno / Stockholm

 **PLANY**
QUALITY
SINCE 1964

**HEAVY
DUTY
TARP**

MARINE AND MARITIME SECTORS

Sertifisert leverandør

ISO 9001
CERTIFIED



Dyktig på produktutvikling

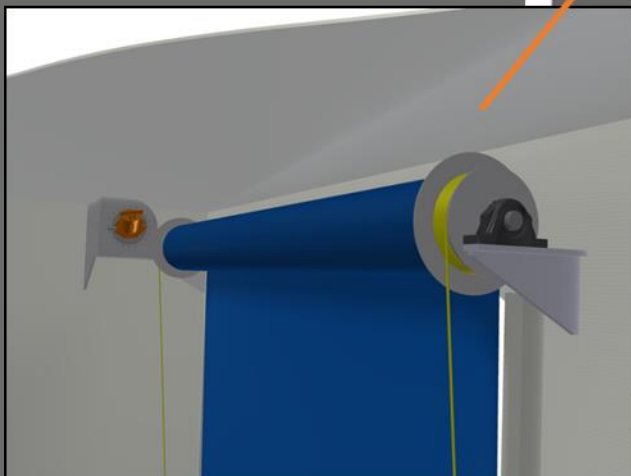
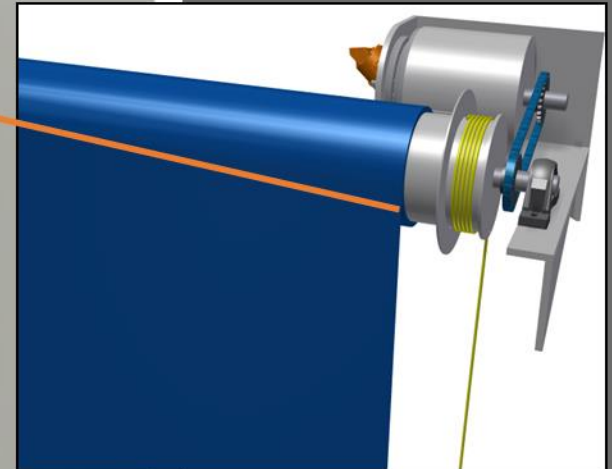
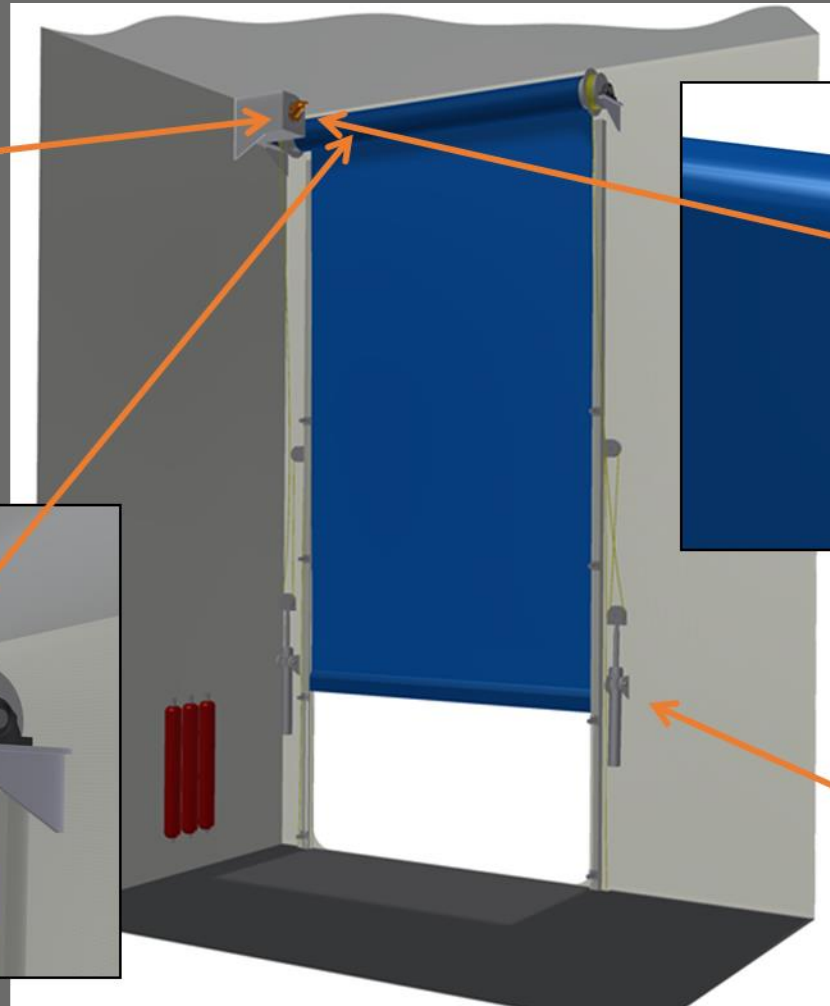

Strammesyndere
2x 10 tonn

**Akter-port til MOB
2 tonn strekk, H4500 B4000
TromsOffshore Arcturus**



Stadig mer kompleks produksjon

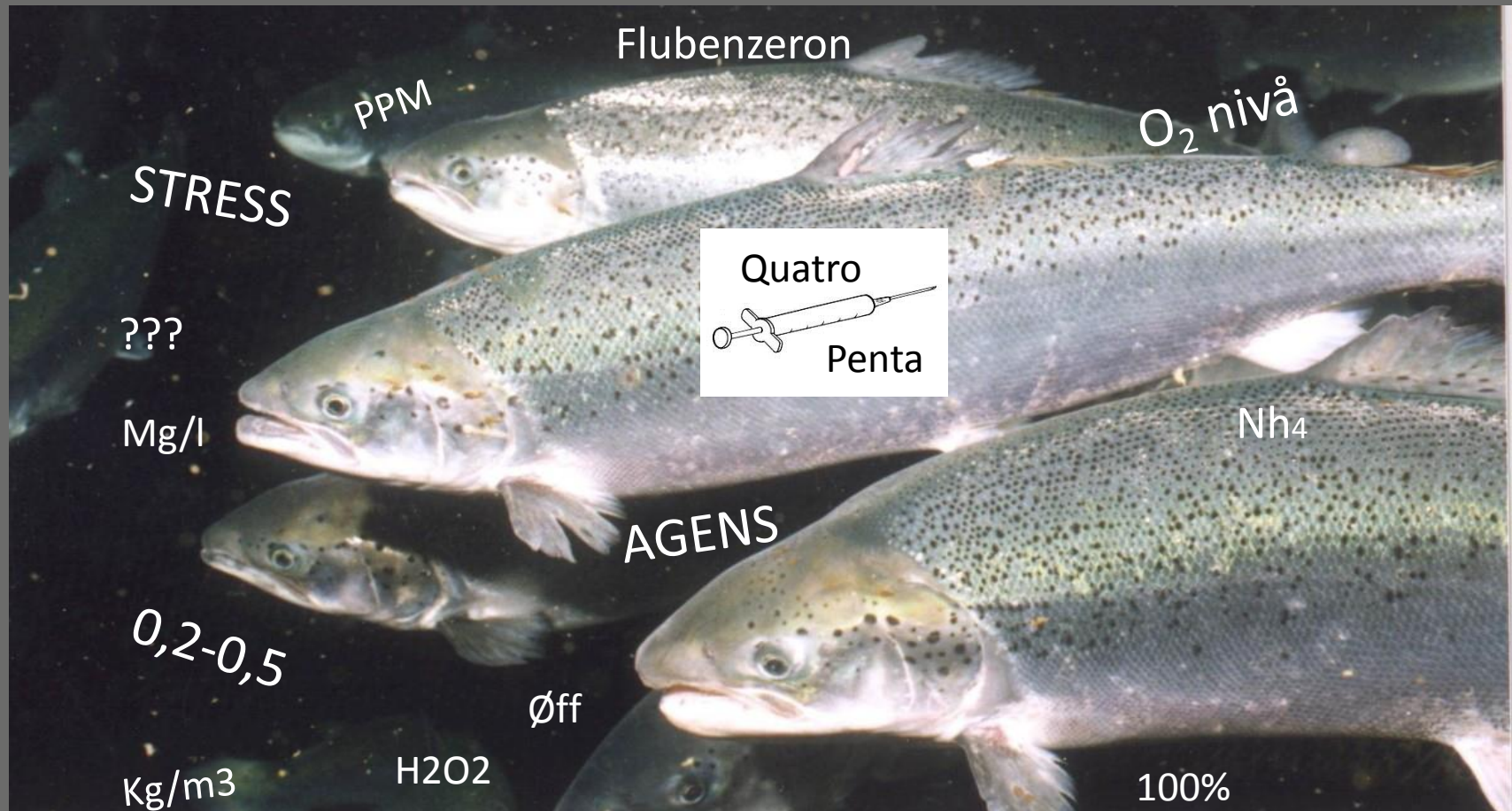

Produksjonskostutvikling

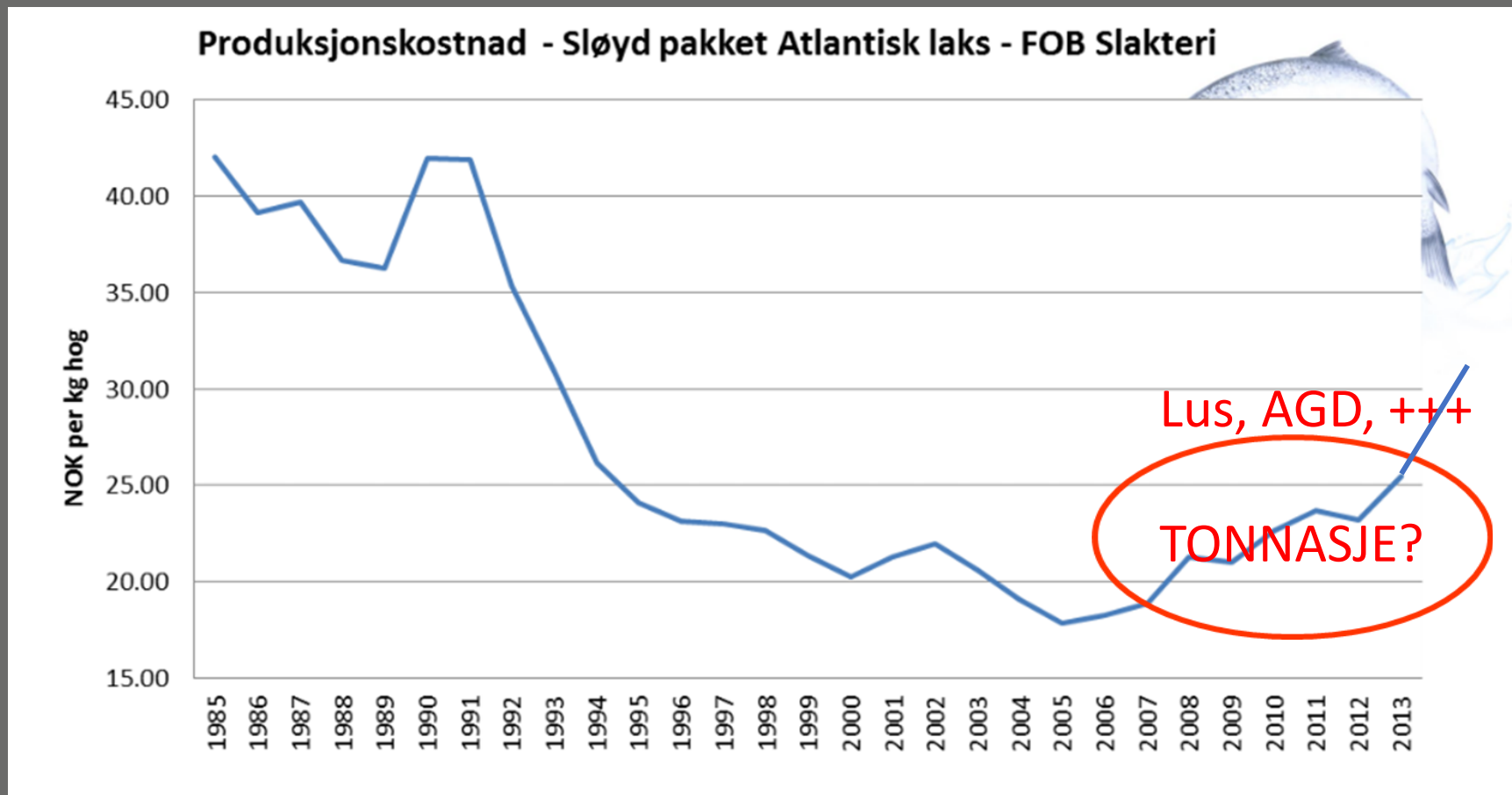

Hovedsynderen (Lepeophtheirus salmonis)



Kilde: Lusedata.no Are Kvistad

Og en god nr 2, AGD (Neoparamoeba perurans)

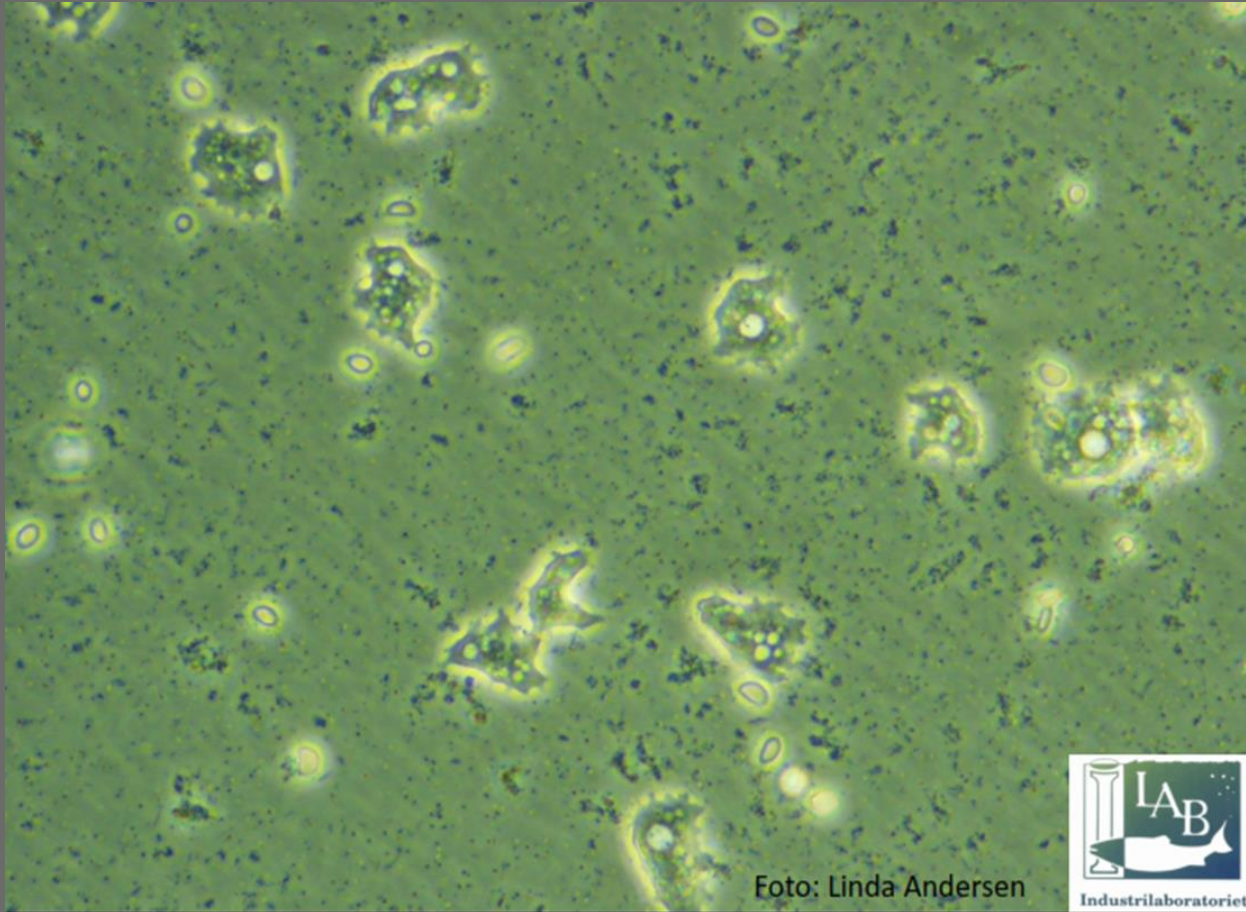

Formsydd

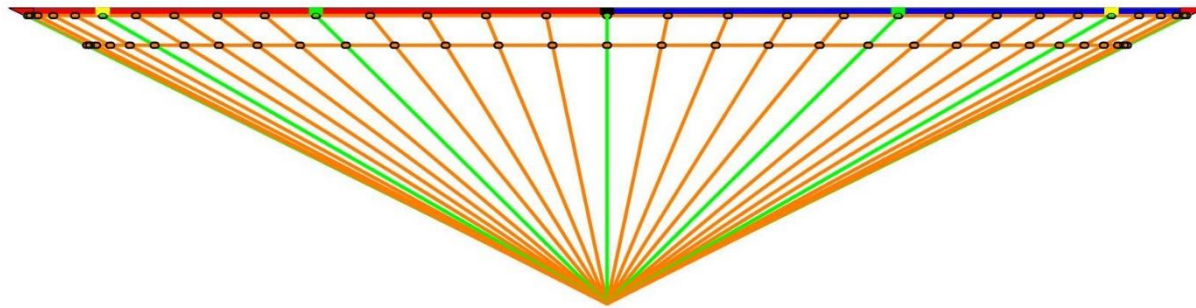

H2O2: 7 NOK/L x (22000m³ x 1000 ppm) = \$\$\$

Kostnad

Resistens

FVB 120

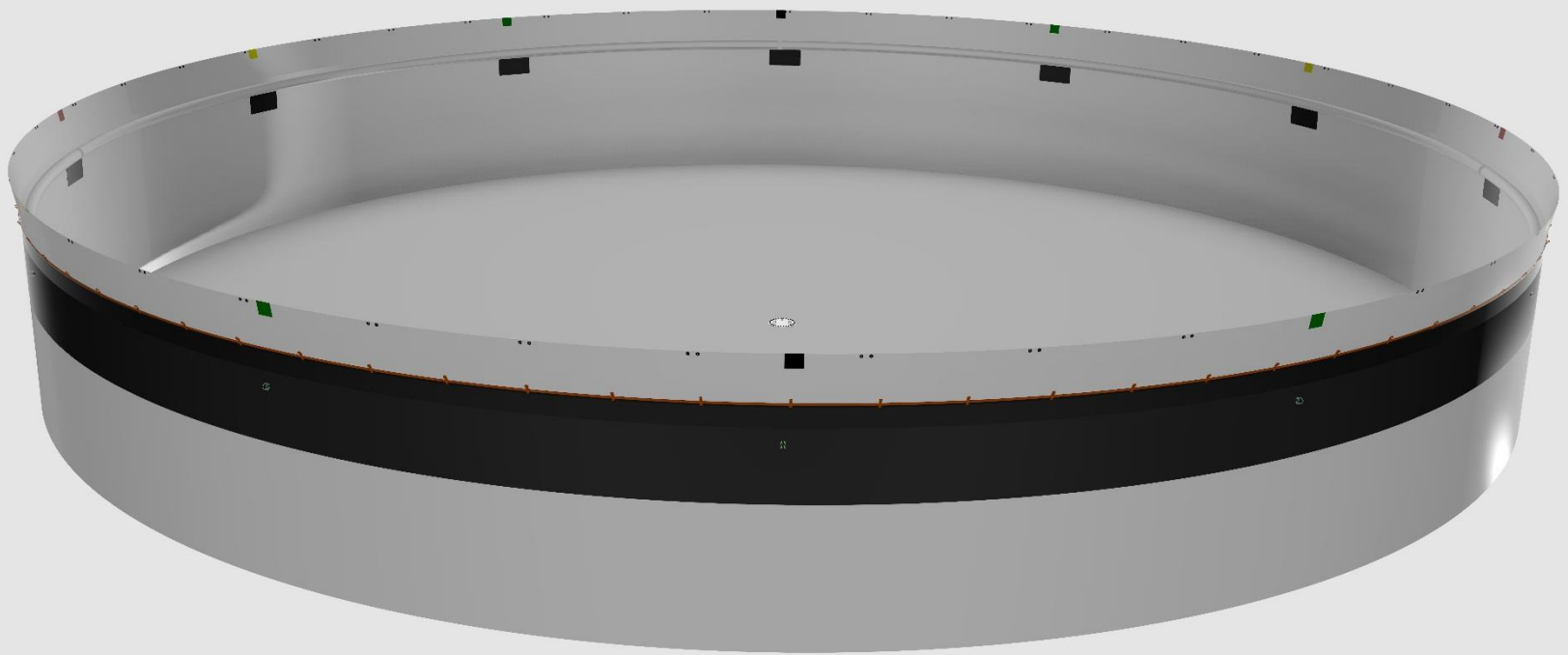

Enkel regnestykke

✓ Spørsmål: Hvor mange parasitter, insekter eller lignende har mennesket gjennom historien greid å utrydde?

Svar:

Enkel filosofi

- ✓ Den beste måten å desimere lusebestanden på er å hinder den i å nå tak i en «vert»
- ✓ Uten vert kan den verken vokse, utvikle eller formere seg
- ✓ Lusebestanden vil holde seg lav i området

Plany Skjold

- Komplette og klare til bruk

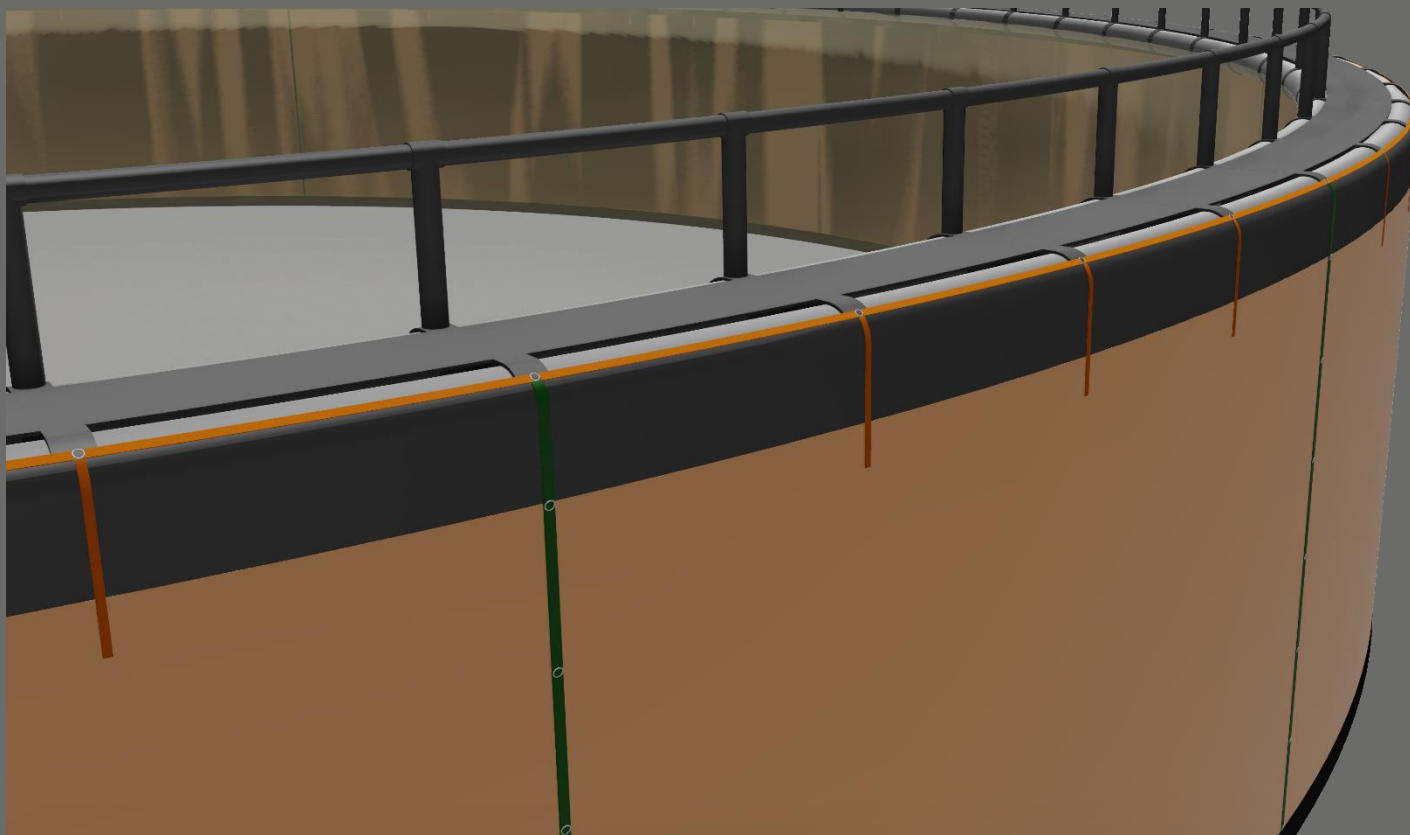

SOLVOX DropIn

Samarbeid mellom AGA og Plany

- SOLVOX DropIn tekniske data:
 - 230 / 400 volt 3 fase – 2,2 kW
 - Tørrvekt ca 50 kg
 - Høyde ca 145 cm
 - Diameter 20 cm
 - Oksygen kapasitet opp til 50 kg/time
 - Produsert i PEH / POM
 - Vann flow 60 m³/time



Kombinasjon er/kan være tingen

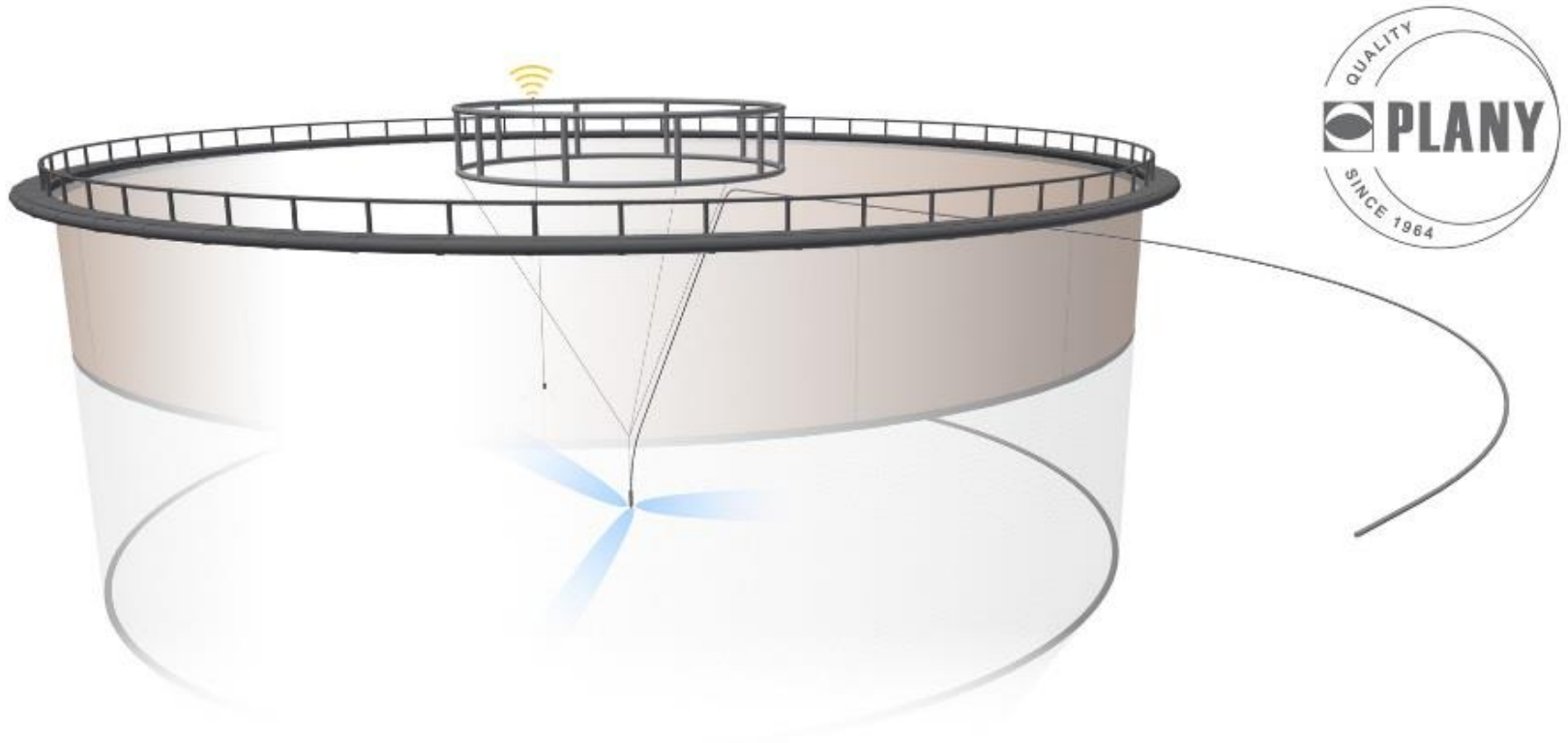

LUSEFILTER

«LUSEKONDOM»



Fjerning av fastsittende: 350 μ m
Fjerning av frittlevende: 150 μ m



SPØRSMÅL OG SVAR

- Produktet er tilgjengelig pr i dag, anslagsvis 30 -40 enheter i bruk pr i dag
- Produksjonskapasiteten er tilstrekkelig
- Hovedutfordring: Å stoppe alle stadier samtidig som stor mengde vann skal passere
- Kapasitet: I teorien stoppes 100% av all »løs» fastsittende lus, men ikke alle andre stadier.
- All håndtering av fisken, rensefisk, skjold
- Kostnad = nesten ikke målbar (10 000 NOK pr 2000 tonn håndtert fisk)

En kan velge å gjøre det vanskelig, men

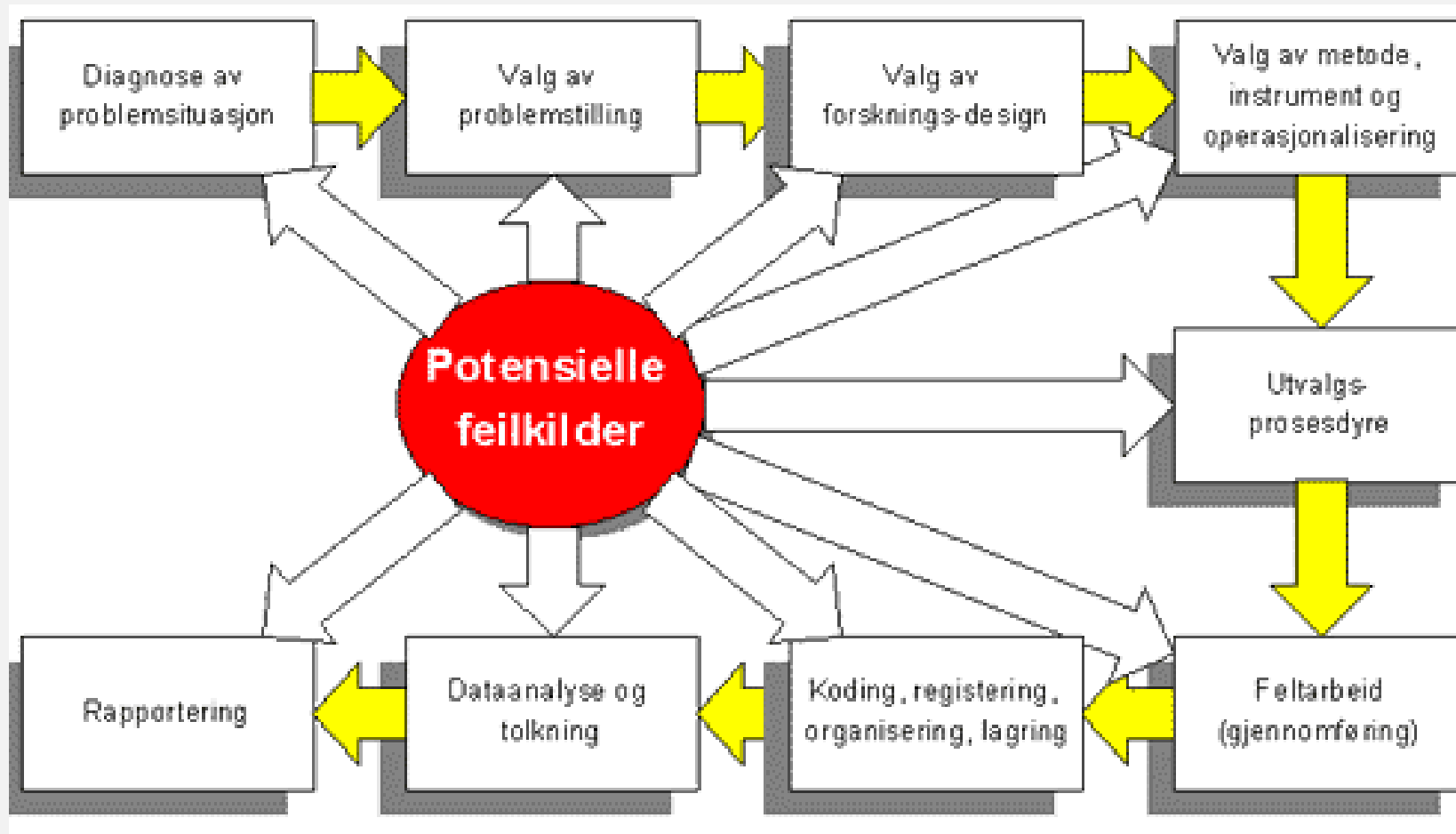

Svaret er enkelt

- Det er idioti å slippe lus tilbake i sjøen!!

Skaff nødvendig beredskap i god tid



KILDE: K BRANDAL

God planlegging lønner seg



Foto: Kenneth Brandal



Takk for oppmerksomheten